

## GV-MFD2401 2MP H.264 WDR Pro Mini Fixed Dome



- 2 Megapixel Progressive Scan WDR Pro CMOS
  - Dual streams from H.264 and MJPEG
  - Up to 30 fps at 1920 x 1080
  - Day and night function (electronic)
  - USB slot for GV-WiFi Adapter or USB hard drive
  - Built-in micro SD card slot (SD/SDHC) for local storage
  - Active Tampering alarm
  - Wide Dynamic Range Pro (WDR Pro)
  - Two-way audio
  - Defog
  - Motion detection
  - Privacy mask
  - IP address filtering
  - iPhone, iPad, Android
  - DC 5V / PoE
  - Megapixel lens
  - Supports iPhone, iPad, Android & 3GPP
  - 31 languages on Web interface
  - ONVIF (Profile S) conformant
- \* No Memory card slot & local storage function for Argentina.

### Introduction

The GV-MFD2401 Series offers an indoor, fixed, mini-sized network camera with different lens options. The camera can process scenes with contrasting intensity of lights and produce clear image using the built-in WDR Pro. The camera is equipped with a USB port which supports wireless connection through GV-WiFi Adapter (optional) or an external storage using a USB hard drive.

### Active Tampering Alarm

Tampered



Focus Change



Camera Shift

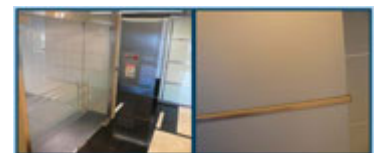

### Models

Models	Iris	Focal Length (mm)	Maximum Aperture	Image Format
MFD2401-0F	Fixed	2.8 mm	F/2.0	1/3"
MFD2401-1F		4 mm	F/1.5	
MFD2401-2F		8 mm	F/1.6	
MFD2401-3F		12 mm		
MFD2401-4F		2.1 mm	F/1.8	

## Dimensions

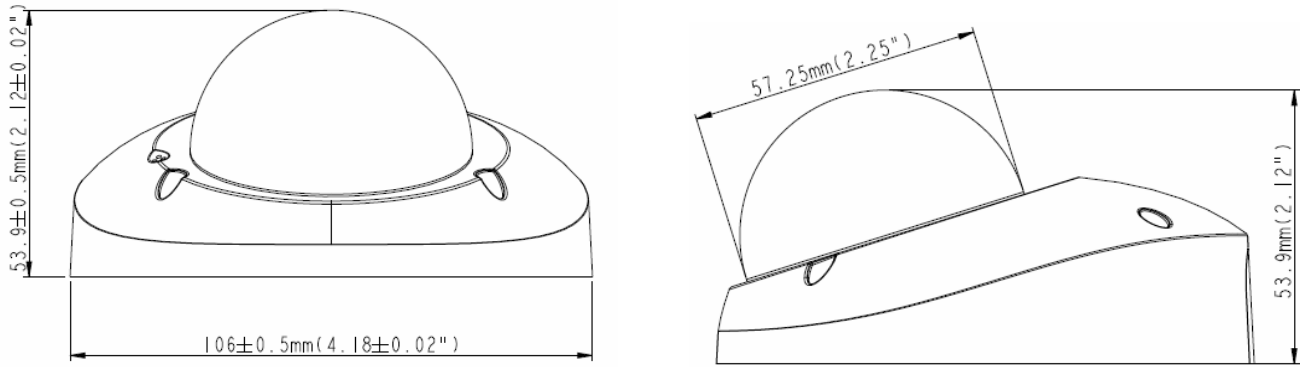

## Specifications

Camera		GV-MFD2401-0F	GV-MFD2401-1F	GV-MFD2401-2F	GV-MFD2401-3F	GV-MFD2401-4F
Image Sensor		1/3.2" progressive scan CMOS				
Picture Elements		1920 (H) x 1080 (V)				
Minimum Illumination	Color	0.08 Lux				
	B/W	0.05 Lux				
Shutter Speed		Automatic, Manual (1/5 ~ 1/8000 sec.)				
White Balance		Automatic, Manual (2800K ~ 8500K)				
Gain Control		Automatic				
S/N Ratio		55 dB				
WDR Pro		Yes				
<b>Lens</b>						
Megapixel		Yes				
Day/Night		Yes (Electronic)				
Iris		Fixed				
Focal Length		2.8 mm	4 mm	8 mm	12 mm	2.1 mm
Maximum Aperture		F/2.0	F/1.5	F/1.6	F/1.6	F/1.8
Mount		M12, Pitch 0.5 mm				
Image Format		1/3"				
Horizontal FOV		79°	58°	31°	20°	112°
Operation	Focus	Fixed				
	Zoom	Fixed				
	Iris	Fixed				
<b>Operation</b>						
Video Compression		H.264, MJPEG				
Video Streaming		Dual streams from H.264 and MJPEG				
Frame Rate		30 fps at 1920 x 1080 * The frame rate and the performance may vary depending on the number of connections and data bitrates (different scenes).				
Image Setting		Brightness, Contrast, Sharpness, Gamma, White Balance, Flicker-less 50/60 Hz, Image Orientation, Shutter Speed, Backlight Compensation, WDR Pro, Defog				
Audio Compression		G.711, AAC (optional)				
Audio Support		Two-Way Audio				
Sensor Input		No				
Alarm Output		No				
<b>Video Resolution</b>						
Main Stream	4:3	1600 x 1200, 1280 x 960, 640 x 480, 320 x 240				
	16:9	1920 x 1080, 1280 x 720, 640 x 360, 448 x 252				
	5:4	1280 x 1024, 640 x 512, 320 x 256				
Sub Stream	4:3	640 x 480, 320 x 240				
	16:9	640 x 360, 448 x 252				
	5:4	640 x 512, 320 x 256				

Network		
Interface	10/100M Ethernet	
Ethernet Protocol	DHCP, DynDNS, FTP, HTTP, HTTPS, NTP, ONVIF (Profile S), PSIA, QoS (DSCP), RTSP, SNMP, SMTP, TCP, UDP, UPnP, 3GPP/ISMA	
Mechanical		
Temperature Detector	Yes	
Camera Angle Adjustment	Pan	-45° ~ 45°
	Tilt	0° ~ 90°
Connectors	Power	2-pin terminal block, PoE
	Ethernet	Ethernet (10/100 Base-T), RJ-45
	Audio	1 In (built-in microphone), 1 Out (RCA female for speaker)
	USB	GV-WiFi Adapter or USB hard drive
Local Storage	Micro SD card slot (SD/SDHC, SD version 2.0 only, Class 10) * <b>SDXC</b> and <b>UHS-I</b> card types are not supported.	
LED Indicator	4 LEDs: Link, ACT, Power, Status	
General		
Camera Housing	black, white	
Environment Temperature	0 °C ~ 50 °C (32 °F ~ 122 °F)	
Humidity	10% to 90% (no condensation)	
Power Source	5V DC/PoE (IEEE 802.3af)	
Max. Power Consumption	6 W	
Dimension	∅ 106 x 53.9 mm (4.2" x 2.1")	
Weight	280 g (0.62 lb)	
Regulatory	CE, FCC, C-Tick, RoHS compliant	
Power over Ethernet		
PoE Standard	IEEE 802.3af Class 3 Power over Ethernet / PD	
PoE Power Supply Type	End-Span	
PoE Power Output	Per Port 48V DC, 350mA. Max. 15.4 watts	
Web Interface		
Installation Management	Web-based configuration	
Maintenance	Firmware upgrade through Web Browser or Utility	
Access from Web Browser	Camera Live View, Video Recording, Change Video Quality, Bandwidth Control, Image Snapshot, Audio, Picture in Picture, Picture and Picture, Privacy Mask, Text Overlay, Digital PTZ	
Language	Arabic / Bulgarian / Czech / Danish / Dutch / English / Finnish / French / German / Greek / Hebrew / Hungarian / Indonesian / Italian / Japanese / Lithuanian / Norwegian / Persian / Polish / Portuguese / Romanian / Russian / Serbian / Simplified Chinese / Slovakian / Slovenian / Spanish / Swedish / Thai / Traditional Chinese / Turkish	
Applications		
Network Storage	GV-NVR, GV-System, GV-Backup Center, GV-Recording Server	
Smart Device Access	GV-Eye for Android smartphone, tablet, iPhone, and iPod Touch GV-Eye HD for iPad	
Live Viewing	IE, mobile phone	
CMS Server support	GV-Control Center, GV-Center V2, GV-VSM	



**Note:**

- Mind the following limitations and requirements for the USB port:
  - The USB hard drive must be of 2.5" or 3.5", version 2.0 or above
  - The USB hard drive's storage capacity must not exceed 2TB
  - USB flash drives and USB hubs are not supported
  - External power supply is required for the USB hard drive
  - To connect the GV-WiFi Adapter, make sure it is connected before the camera is powered on.
- Specifications are subject to change without notice.

## Packing List

- |                           |                                     |
|---------------------------|-------------------------------------|
| 1. Mini Fixed Dome        | 7. USB / Audio Y-cable              |
| 2. Torx Wrench            | 8. GV-IPCAM H.264 Quick Start Guide |
| 3. Self Tapping Screw x 2 | 9. GV-IPCAM H.264 Software CD       |
| 4. Screw Anchor x 2       | 10. GV-NVR Quick Start Guide        |
| 5. Cable stopper x 1      | 11. GV-NVR Software DVD             |
| 6. Short-Body RJ-45 Plug  |                                     |

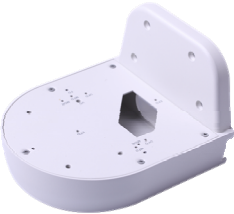
## Accessories

Model No./Name	Details
<b>GV-Mount900 Wall Mount Bracket</b> 	Dimensions: 154 x 108 x 50 mm (6.1" x 4.3" x 2") Weight: 240 g (0.53 lb)
<b>GV-Mount909 Wall Mount Bracket</b> 	Dimensions: 170 x 150 x 110 mm (6.7" x 5.9" x 4.3") Weight: 610 g (1.34 lb)
<b>GV-Mount910 Power Box Mount Bracket</b> 	Dimensions: 112 x 98 x 7.5 mm (4.4" x 3.9" x 0.3") Weight: 105 g (0.23 lb)
<b>GV-Mount913 Power Box Mount Bracket</b> 	Dimensions: $\varnothing$ 146 x 7.5 mm ( $\varnothing$ 5.7" x 0.3") Weight: 180 g (0.4 lb)
<b>GV-PA191 PoE Adapter</b> 	Weight: 130 g (0.29 lb) Dimensions (H x W x D): 43 x 69 x 40 mm (1.69" x 2.72" x 1.57")
<b>Power Adapter</b>	Power adapters are available in 4 regions: U.S.A., Australia, U.K and Europe.
<b>GV-POE Switch</b>	The GV-POE Switch is designed to provide power along with network connection for IP devices. The GV-POE Switch is available in various models with different numbers and types of ports.

Model No./Name	Details
<p data-bbox="71 201 239 235">GV-WiFi Adaptor</p> 	<p data-bbox="590 201 798 235">Weight: 20 g (0.04 lb)</p> <p data-bbox="590 235 1101 268">Dimensions: 15 x 15 x 155 mm (0.59" x 0.59" x 6.10")</p> <p data-bbox="590 268 1053 302">Supplied with mini USB to standard USB adapter.</p>