

GV-FE520 5MP H.264 Fisheye IP Camera

GV-FE520



* GV-FE520 is excluded from Japan, EU and German market.

Introduction

The GV-FE520 is a fisheye camera that allows you to monitor all angles of a location using just one camera. The distorted hemispherical image of the fisheye camera will be converted into the conventional rectilinear projection.

Without installing any software, you can watch live view and utilize functions such as motion detection, privacy mask, and alert notification through the Web interface using an IE browser. In addition, the GV-FE520 seamlessly integrates with the GV-System, providing advanced monitoring and video management features.

The GV-Fisheye IP Camera is designed to be mounted on the ceiling, wall or ground. There are two ways to mount the GV-FE520 on the ceiling, **Hard Ceiling Mount** and **In-Ceiling Mount**. In-Ceiling Mount allows the GV-FE520 to be mounted into the ceiling, revealing a small portion of the camera.

Key Features

- 5MP progressive scan CMOS
- H.264 and MJPEG
- [Digital Object Tracking](#)
- Wide Dynamic Range (WDR)
- Electronic Day/Night function
- Provides 360 and 180 degrees panorama view
- No mechanical moving parts
- Built-in Web server for monitoring through IE browser
- Virtual PTZ function
- Auto Pan function
- Different angle of view accessible by multiple users at the same time
- Up to 10 fps at 2560 x 1920
- Playback from any view angle and zoom level
- Privacy mask
- Visual automation
- Tampering alarm
- Two-way audio
- One sensor input and alarm output
- DC 12V / AC 24V / PoE
- Built-in micro SD card slot (SD/SDHC) for local storage
- 31 languages on Web interface
- ONVIF (Profile S) conformant

* No Memory Card Slot & local storage function for Argentina.

Fisheye Source Image



Single View



2 x 180° View

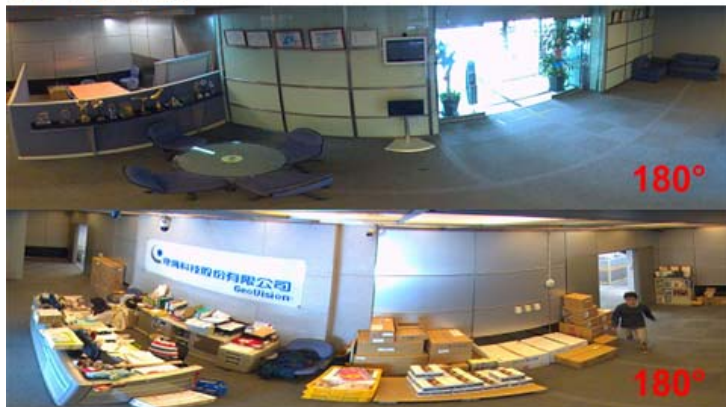

360° View



Quad View

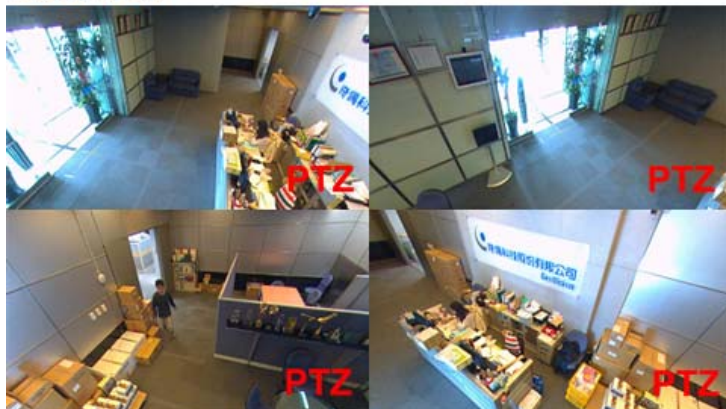

Dimensions

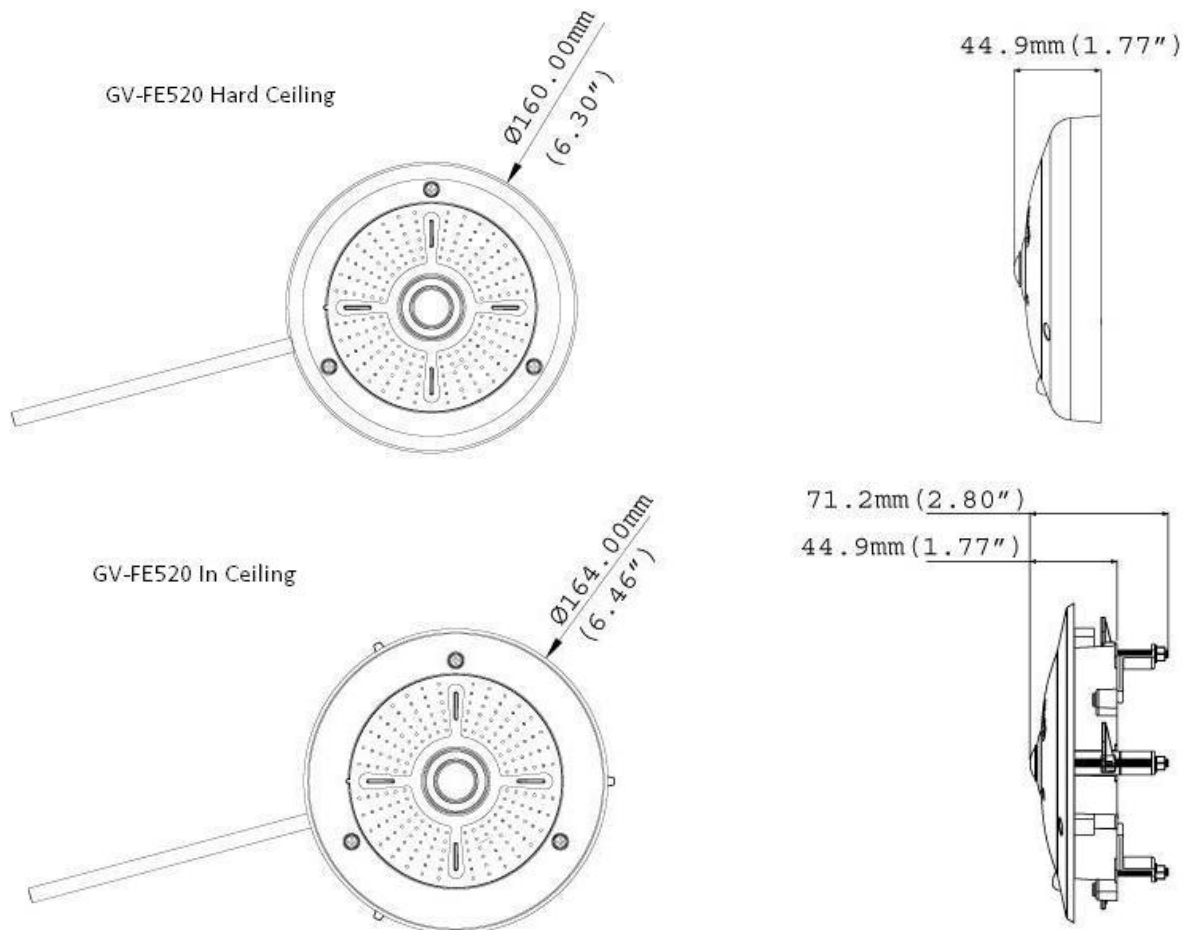

Specifications

System Requirements

OS	32-bit	Windows XP / Vista / 7 / Server 2008
	64-bit	Windows 7 / Server 2008
GV-System Version	GV-System V8.5.0.0 or later	
Browser	Internet Explorer 7.x or later	

Camera

Image Sensor	1/2.5" progressive scan CMOS	
Picture Elements	2560 (H) x 1920 (V)	
Minimum Illumination	Color	0.15 Lux
	B/W	0.10 Lux
Shutter Speed	Automatic, Manual (1/5 – 1/8000 sec.)	
White Balance	Automatic, Manual (2800K – 8500K)	

Optics Lens

Megapixel	Yes	
Day/Night	Yes (electronic)	
Iris	Fixed Iris	
Focal Length	1.6 mm	
Aperture	F/2	
Mount	M12, Pitch 0.5 mm	
Image Format	4.7 mm (Image Circle)	
Operation	Focus	Fixed
	Zoom	Fixed
	Iris	Fixed

Operation			
Video Compression	H.264, MJPEG		
Video Streaming	Single stream from H.264 or MJPEG		
Frame Rate	10 fps at 2560 x 1920		
Image Setting	Brightness, Contrast, Sharpness, Gamma, White Balance, Flicker-less, Backlight Compensation, Image Orientation, Shutter Speed, Day / Night, WDR, Defog		
Audio Compression	G.711, AAC (optional)		
Audio Support	Two-Way Audio		
Sensor Input	1 Digital Input (Dry Contact)		
Alarm Output	1 Digital Output		
Network			
Interface	10/100 Ethernet		
Protocol	HTTP, HTTPS, TCP, UDP, SMTP, FTP, DHCP, NTP, UPnP, DynDNS, RTSP, PSIA, SNMP, QoS (DSCP), ONVIF (Profile S)		
Mechanical			
Lens Mounting	M12, Pitch 0.5 mm (0.02")		
Temperature Detector	Yes		
Mechanical			
Connectors	Power	Terminal block (3 pin), PoE	
	Ethernet	Ethernet (10/100 Base-T), RJ-45 Connector	
	Audio	Built-in microphone and speaker	
	Digital I/O	I/O Wire	
	Auto Iris	None	
	Local Storage	Micro SD card slot (SD/SDHC, SD version 2.0 only, Class 10) * SDXC and UHS-I card types are not supported	
	TV-Out	None	
General			
Environment Temperature	0 °C ~ 50 °C (32 °F ~ 122 °F)		
Humidity	10% to 90% (no condensation)		
Power Source	12V DC / 24V AC / PoE (IEEE802.3af)		
Max. Power Consumption	5W		
Dimensions	Camera Body	Hard-Ceiling Mount	ø 160 x 44.9 mm (6.30" x 1.77")
		In-Ceiling Mount	ø 164 x 44.9 mm (6.46" x 1.77")
	Cable Length	1 m (3.28 ft.)	
	Cable Diameter	ø 8 mm (0.31")	
	Maximum Connector Diameter	ø 28.5 mm (1.12")	
Weight	650 g (1.43 lb)		
Regulatory	CE, FCC, C-Tick, RoHS compliant		
Power over Ethernet			
PoE Standard	IEEE 802.3af Power over Ethernet / PSE		
PoE Power Supply Type	End-Span		
PoE Power Output	Per Port 48V DC, 350mA. Max. 15.4 watts		
Web Interface			
Installation Management	Web-based configuration		
Maintenance	Firmware upgrade through Web Browser or Utility		
Access from Web Browser	Camera Live View, Video Recording, Change Video Quality, Bandwidth Control, Image Snapshot, Digital I/O Control, Audio, Picture in Picture, Picture and Picture, Privacy Mask, Visual Automation, Tampering Alarm, Auto Pan Function, Virtual PTZ, Motion Detection, Wide Angle Lens Dewarping, Text Overlay, Digital PTZ		
Language	Arabic / Bulgarian / Czech / Danish / Dutch / English / Finnish / French / German / Greek / Hebrew / Hungarian / Indonesian / Italian / Japanese / Lithuanian / Norwegian / Persian / Polish / Portuguese / Romanian / Russian / Serbian / Simplified Chinese / Slovakian / Slovenian / Spanish / Swedish / Thai / Traditional Chinese / Turkish		

Applications

Network Storage	GV-NVR, GV-System, GV-Backup Center, GV-Recording Server
Live Viewing	IE , mobile phone
CMS Server Support	GV-Control Center, GV-Center V2, GV-VSM

Note:







- Specifications are subject to change without notice.
- Mind the following when using a memory card for recording:
 - Recorded data on the memory card can be damaged or lost if the data are accessed while the camera is under physical shock, power interruption, memory card detachment or when the memory card reaches the end of its lifespan. No guarantee is provided for such causes.
 - To avoid power outage, it is highly suggested to apply a battery backup (UPS).
 - For better performance, it is highly suggested to use Micro SD card of MLC NAND flash, Class 10.
 - Replace the memory card when its read/write speed is lower than 6 MB/s or when the memory card is frequently undetected by the camera.

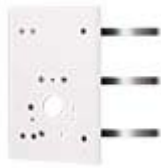

Packing List

- | | |
|--------------------------------------|------------------------------------|
| 1. Fisheye Camera | 5. Camera Cover (In-Ceiling Mount) |
| 2. Camera Cover (Hard Ceiling Mount) | 6. Screw (In-Ceiling Mount) x 3 |
| 3. Screw (Hard Ceiling Mount) x 3 | 7. Support Bracket x 3 |
| 4. Plastic Screw Anchor x 3 | 8. Torx Wrench |

Accessories

Model No.	Name		Details
GV-Mount100	Straight Tube and Junction Box Kit		Dimensions: 200 x 170 x 257.5 mm (7.9" x 6.7" x 10.1") Weight: 3.17 kg (6.99 lb)
GV-Mount101	Straight Tube Kit		Dimensions: 219 x 125 x 332 mm (8.6" x 4.9" x 13.1") Weight: 1.8 kg (3.97 lb)
GV-Mount200	Wall Pendant Tube		Dimensions: 225 x 140 x 250 mm (8.9" x 5.5" x 9.8") Weight: 900 g (1.98 lb)
GV-Mount203	Wall Pendant Tube and Junction Box Kit		Dimensions: 315 x 195.5 x 225 mm (12.4" x 7.7" x 8.9") Weight: 2.95 kg (6.5 lb)

Model No.	Name	Details
GV-Mount205	Wall Mount Bracket Kit	 <p>Dimensions: 126.5 x 203 x 160 mm / 5 x 8 x 6.3" (L x W x diameter) Weight: 0.5 kg / 1.1 lb</p>
GV-Mount300	Convex Corner Adapter Kit	 <p>Dimensions: 238.6 x 409.5 mm (9.4" x 16.1") Weight: 4.27 kg (9.41 lb)</p>
GV-Mount310	Concave Corner Adapter Kit	 <p>Dimensions: 238.6 x 409.5 mm (9.4" x 16.1") Weight: 4.27 kg (9.41 lb)</p>
GV-Mount400	Pole Mount Bracket Kit (Ø 4" ~ 6")	 <p>Bracket: 241 x 161 mm (9.5" x 6.3") Weight: 1.70 kg (3.75 lb) Steel Strap Diameter: Ø 4" ~ 6"</p>
GV-Mount410	Pole Mount Bracket Kit (Ø 6" ~ 7.5")	 <p>Bracket: 241 x 161 mm (9.5" x 6.3") Weight: 1.70 kg (3.75 lb) Steel Strap Diameter: Ø 6" ~ 7.5"</p>
GV-Mount702	Extension Tube	 <p>Four options are available. Dimensions: Ø 5.4 x 10 or 20 or 30 or 50 cm (Ø 2.1" x 3.9" or 7.9" or 11.8" or 19.7") Weight: 180 g or 390 g or 550 g or 800 g (0.4 lb or 0.86 lb or 1.21lb or 1.76 lb)</p>
GV-Mount903	Fisheye Dome Housing	 <p>Dimensions: Ø 186 x 97.5 mm (Ø 7.3" x 3.8") Weight: 700 g (1.54 lb)</p>

Model No.	Name	Details
GV-Mount904	Tilting Wall Mount Bracket	 <p>Dimensions: \varnothing 159.1 x 40.5 mm (\varnothing 6.3" x 1.6") Weight: 400 g (0.88 lb)</p>
GV-Mount912	Power Box Mount Bracket	 <p>Dimensions: \varnothing 146 x 10.5 mm (\varnothing 5.7" x 0.4") Weight: 180 g (0.4 lb)</p>
GV-PA191	Power over Ethernet (PoE) Adapter	 <p>The GV-PA191 is a Power over Ethernet (PoE) adapter designed to provide power to the IP device through a single Ethernet cable.</p>
Power Adapter		Power adapters are available in 4 regions: U.S.A., Australia, U.K and Europe.
GV-POE Switch		The GV-POE Switch is designed to provide power along with network connection for IP devices. The GV-POE Switch is available in various models with different numbers and types of ports.